

Original user manual

Body Drum



1. Declaration of Conformity

EU Declaration of Conformity

Manufacturer: Jasopels Production A/S Tel. +45 76 94 35 00

Address: Fabriksvej 19 DK-7441 Bording

Machine: Self-emptying Body Drum

Type: 20-0000

Jasopels Production A/S declares that this product is in accordance with the following EU directives:

89/336 EEC

98/37 EEC

Furthermore, we declare that the following harmonized standards have been applied:

EN 60204-1

EN 983

Place and date: Frederikshavn, July 1, 2005

Name: CEO Janne Jensen

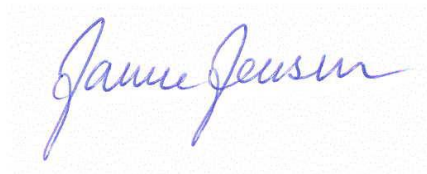

2. Table of contents

1. Declaration of Conformity	2
2. Table of contents	3
3. Preface	4
4. Symbol explanation	5
5. Introduction of the machine	6
6. Start-up	7
7. Operation	9
8. Maintenance	11
9. Technical data	12
10. Circuit and airflow diagram	13
11. Spare parts list	16
12. Troubleshooting	18
13. Conveyor belt	19

3. Preface

- This User Manual is an important part of your new machine. Read the manual thoroughly and use it as a reference book.
- This manual contains important information about safety and the correct use of the machine.
- The manual should be stored with the machine. It is important that the user manual is supplied with the machine upon resale and lending.
- The user of the machine must make sure that the operator, service personnel and others who have access to the machine have been instructed in the correct use and handling of the machine. Refer to this user manual for further information.

4. Symbol explanation

Please read this user manual and follow the included instructions. In order to emphasize certain information, the following expressions are used:

- Note!



A triangle containing an exclamation mark is a symbol that warns you of important instructions or information concerning this machine.

- Danger!



A triangle containing a flash of lightning is a symbol that warns you of “High Voltage”.

5. Introduction of the machine

- The BS Teknik Self-Emptying Body Drum has been designed for tumbling mink.
- Thanks to the drum's large capacity it is possible to tumble up to 100 males or 140 females (though no more than 280 kg) at a time.
- The drum's self-emptying feature has made the operator's working environment considerably better. Before it was necessary for the operator to work in a dusty environment, as the mink had to be manually removed from the drum.
- The drum's construction includes an automatic control unit, which makes the machine particularly easy to operate. After mink and sawdust have been put into the drum, the operator sets the tumbling time on the control panel and presses **START**. When the tumbling process is finished, the mink are automatically removed from the drum at its end. After this the drum stops and is ready for the next batch. The automatic control system has also made it possible to remove the mink from the drum in several smaller batches.

Note!

- The user of the machine must make sure that the operator, service personnel and others who have access to the machine have been instructed in the correct use and handling of the machine. Refer to this user manual for further information.
- The machine may only be used for the purpose it has been designed for.
- If any problems should occur with the machine or its operation, they must not be fixed before the machine is properly switched off, unless a correction can be made via the machine's control buttons.
- The user manual should always be kept available for the operator.



6. Start-up

- Before start-up the machine must be placed on a firm and level floor. The machine must not wobble. In order to reduce the amount of wasted sawdust, it is recommended to position the emptying end of the drum about 5 cm higher than the drum's back end.

DANGER!

In order to avoid crushing accidents by the back handles and the trailing wheel, the machine needs to be placed in such a way that there is no access to the back side of the drum (it could e.g. be placed against a wall).

If this is not possible, you can purchase an extra screen for the wheel from your dealer.



- The manufacturer has equipped the machine with a 5-pin 16 A CEE plug at the end of the power supply cable which is to be connected to an outlet with 3P+N+PE. A compressed air filter with a quick release coupling has been installed on the drum's stand, where the compressor's tube is connected.

- It is important to make sure that the drum's direction of rotation is correct. To do that close the loading lid and activate the **START** button. The lid should now move upwards. If this – contrary to your expectations – is not the case, stop the drum immediately by pressing the **STOP** button. Interchange the two phases located on the thermo relay (fig. 5.5) and repeat the test.

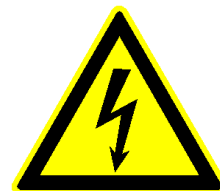

DANGER!

Always disconnect the machine's compressed air and power supply before maintenance, cleaning and other services are performed on the machine.



- The Body Drum is now ready to be used.

It is recommended to put up a net table or possibly a BS body conveyor belt at the emptying end of the drum, where the mink are unloaded. The wide range of Jasopels' products includes a specially designed net table as well as an automatic conveyor belt that are well suited for this drum.

.....
: **In order to avoid potential damage to the control unit's**
: **micro controls and the rest of the machine's electrical**
: **system due to thunderstorms, it is recommended to**
: **disconnect the machine from its electrical power**
: **source whenever it is not being used.**
.....



7. Operation

- Start by filling the drum with mink and sawdust. The proportions should be about 50 kg of sawdust for 100 males or 140 females. During normal operation there is no need to change the sawdust in the drum. However, it does need to be refilled regularly as waste of small amounts of sawdust should be expected at the emptying end and some of the sawdust will leave the drum with the animals as well.
- Close the lid and make sure that the locking mountings are in the locked position.
- Set the tumbling time on the timer switch (fig. 1). There are 9 steps to choose from between 3 and 24 minutes. Choosing position 9 will extend the tumbling time to one hour.

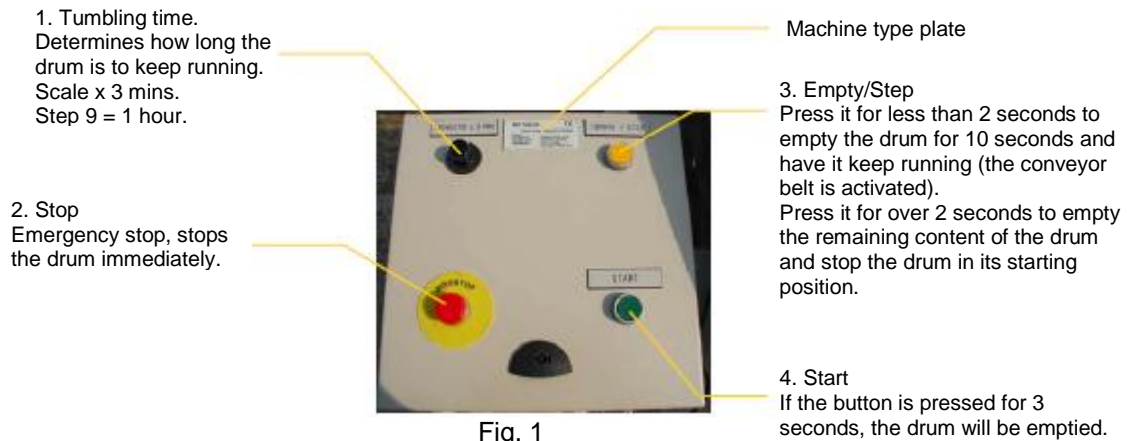

Fig. 1

Remember! The lid must always be closed before you push the START button!

Press the green **START** button (fig. 1) to start the tumbling process.

The body drum will now start the tumbling process and it will keep running for the set amount of time. After that the mink will be automatically removed from the drum at the end of the drum and the drum will stop.

If you wish to empty the drum before the set time is up, you can do so by pressing the yellow **EMPTY** button (fig. 1) for more than 2 seconds. The drum will be emptied and it will stop in its starting position.

You can stop the tumbling process at any time by pressing the red STOP button (fig. 1).

EMERGENCY STOP.



If you do not wish to empty the drum completely at once, press the **EMPTY** button for less than 2 seconds. This will cause the machine to empty the drum for 10 seconds and resume the tumbling process after that. If you want another batch removed from the drum, press the **EMPTY** button for less than 2 seconds again. If you press the **EMPTY** button for over 2 seconds, whatever amount of mink is left in the drum will be removed from it as described above.

When sawdust is to be removed from the drum, the drum's lid has to be removed. This is done by opening the lid completely and pushing it out of its hinges. After that start the drum and let it run for several minutes. The sawdust will now fall out of the drum, on the floor underneath of the drum.

8. Maintenance

DANGER!

Always disconnect the machine's power supply before maintenance, cleaning and other services are performed on the machine.



- The compressed air filter's water separator can be emptied by pressing the button under the glass until the glass is empty.
- The water separator can also empty itself if the air pressure tube on the quick release coupling is removed.

DANGER!

If you need to do maintenance work inside the drum, the power cable **MUST** be removed from the wall outlet before you start.



9. Technical data

- Electrical connection 3 x 400 V+N+PE 5-pin CEE plug
- Power consumption 3,7 A
- Air connection Quick release coupling
- Compressed air consumption Max. 8 bar 2 l/min
- Dimensions
 - Height: 182 cm
 - Length: 230 cm
 - Width: 124 cm

10. Circuit and airflow diagram

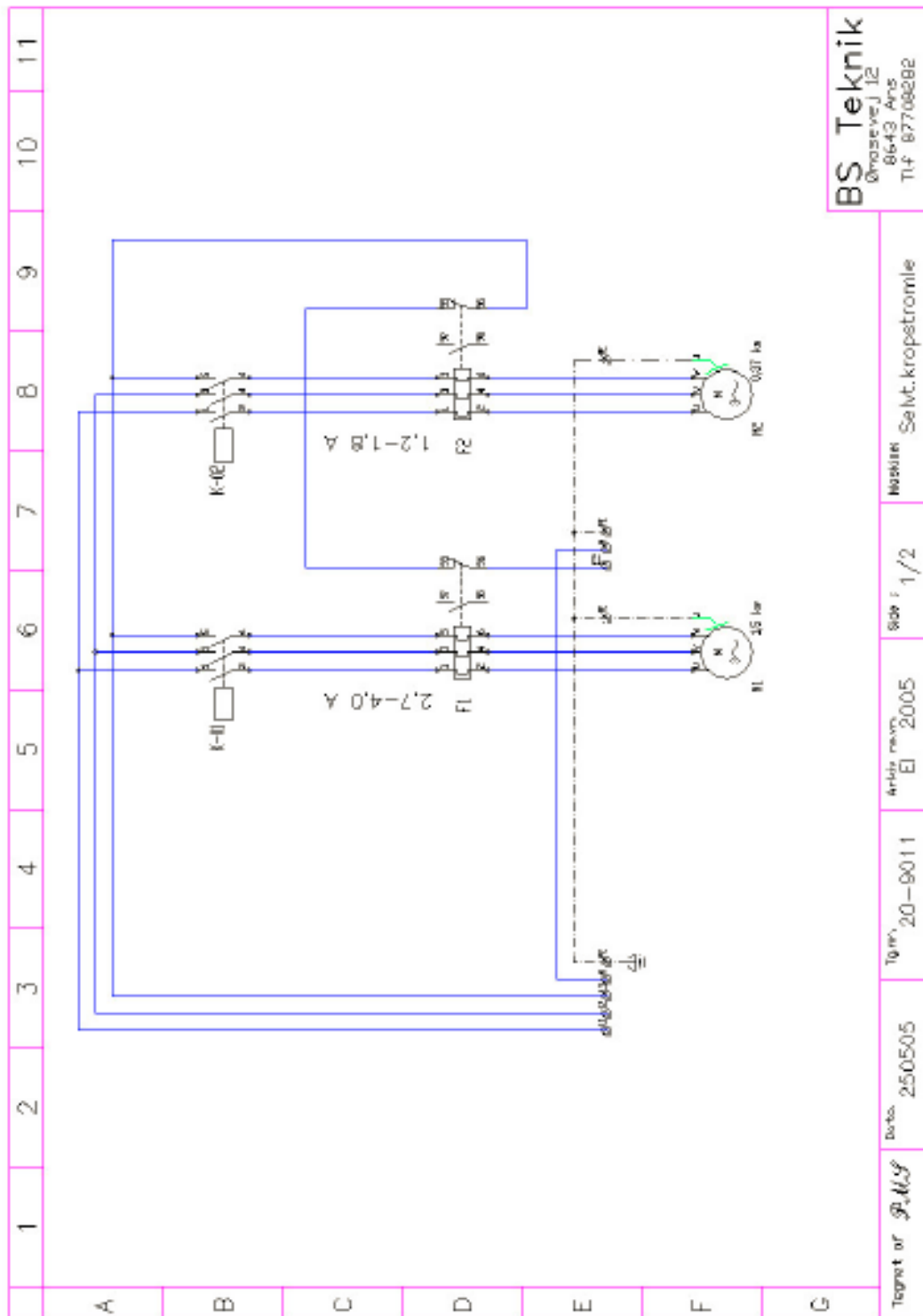

BS Teknik

Ørnavej 12
8643 Års
Tlf: 87708282

Moskva Selvt. kropstromle

Side 1/2

Årshjælp EI 2005

Tøjnr. 20-9011

Dato: 25.05.05

Tegnet af *P.H.J.*

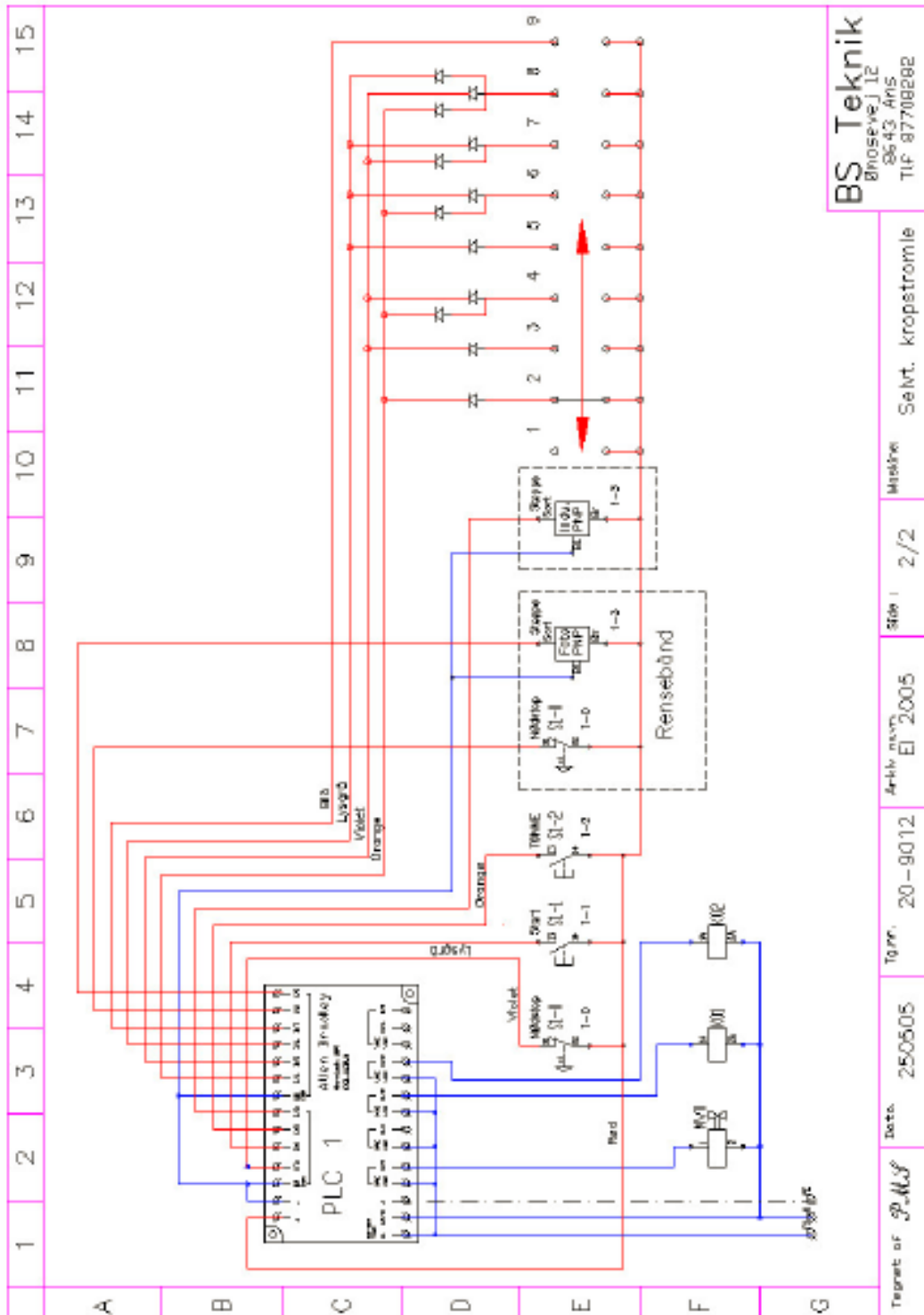

BS Teknik
 Brosevej 12
 8643 Års
 Tlf: 87708882

Teigret af <i>J. H. Jensen</i>	Data: 250505	Tegn.: 20-9012	År/hv. rev. EI 2005	Side: 2/2	Masine: Selvt. kropstromle
--------------------------------	--------------	----------------	---------------------	-----------	----------------------------

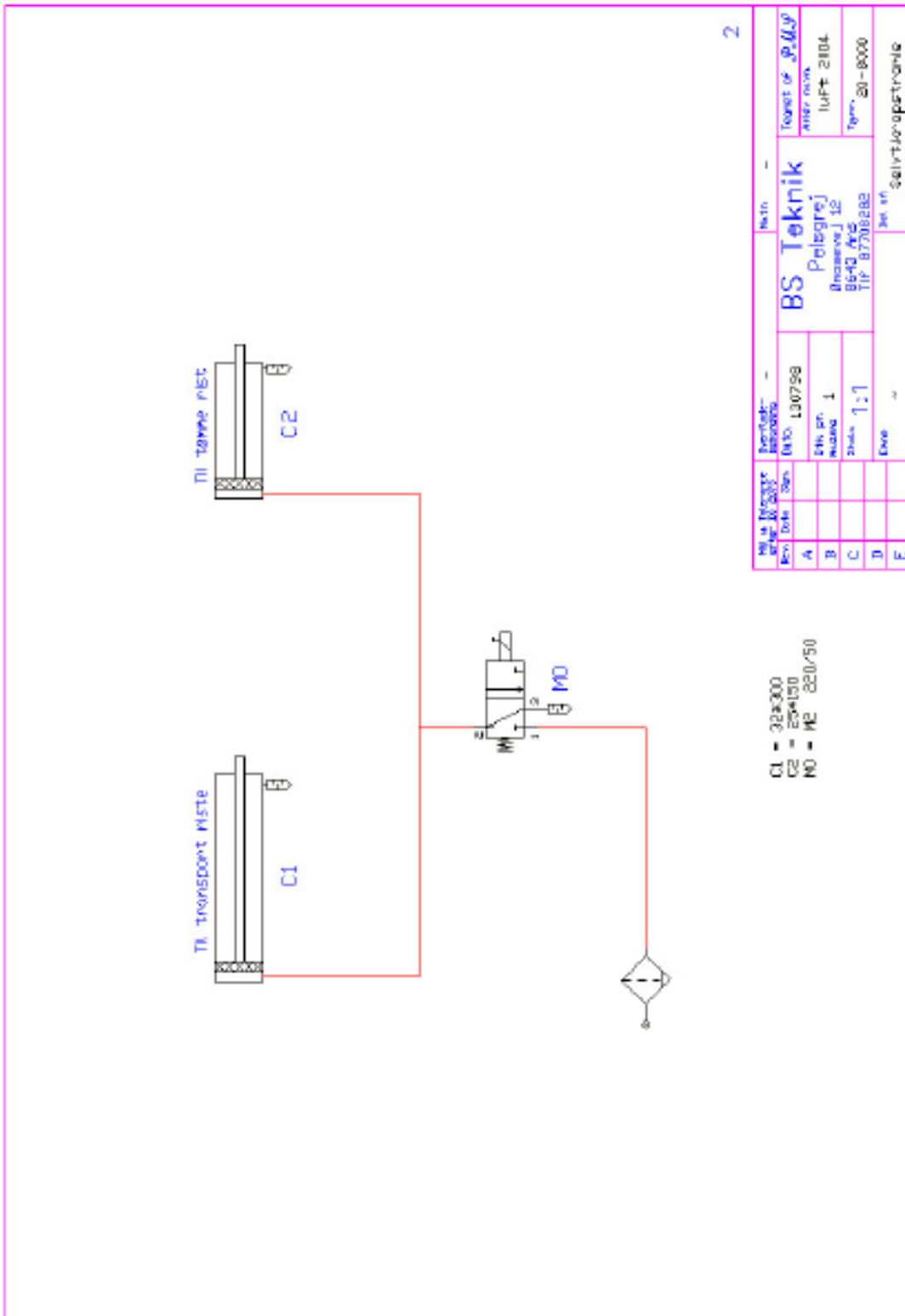

11. Spare parts list

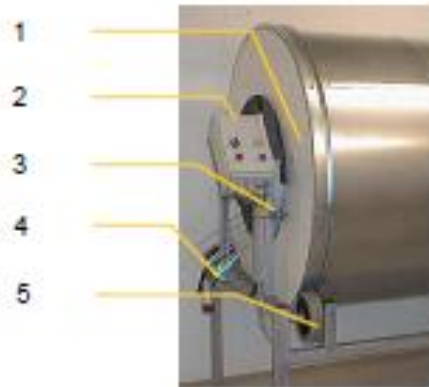

Fig. 2

Fig. no.	BS number	Spare part number	Name
2.1	5912-31025150	1260,25,150	Cylinder
2.2	5926-22819100	PC 28 19	Fibox box bottom 28*19*10
2.2	5926-22819033	HS10255	Fibox lid with hinge and screw
2.2	5926-14300320	ETA cabinet B300*A300*D150	ST3-315- BS – KRTR
2.3	5923-14002220	IPCT1814 pnp	Inductive sensing device Ø18 PNP NO
2.4	5914-32001510	Filter 1/4 100	Compressed air filter
2.5	5150-00201050	Ø 200 m.6204 bearings	Trailing wheel for drum

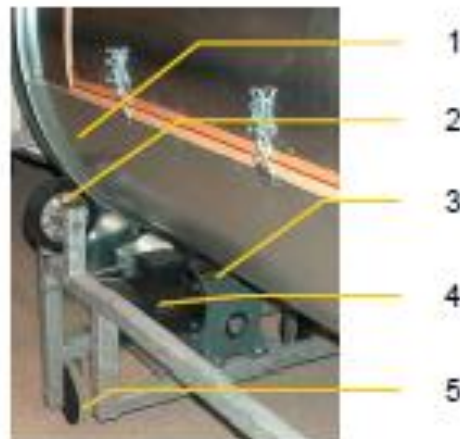

Fig. 3

Fig. no.	BS number	Spare part number	Name
3.1	5912-31032300	1260,32,300	Cylinder
3.2	5150-00201050	Ø 200 m.6204 bearings	Trailing wheel for drum
3.3	5935-13874020035	LPC 87-40-200-Ø24-Ø35	Right angle gear unit
3.4	5931-10150205	ST 90 SC 2 1.5 KW 2800	Motor
3.5	5150-00201060	Ø 200 / Ø20	Travel wheel

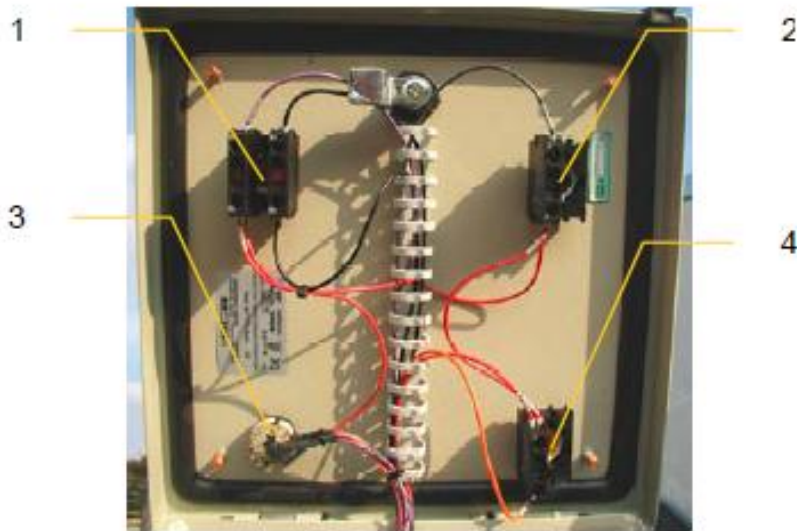

Fig. 4

Fig. no.	BS number	Spare part number	Name
4.1	5924-74011020	BET01	B&J plug element 1 NC
4.2	5924-74011010	B3M	B&J coupling element
4.3	5924-60209010		Timer (version with 4 wires)
4.4	5924-74011030	B3T10	B&J plug element 1 NO



Fig. 5

Fig. no.	BS number	Spare part number	Name
5.1	5921-14000110	1761-L16BWA	Micro controller 1761-L16BWA
5.2	5925-14020030	K2-12A01-230V	B&J contactor K2-12A01-230V
5.3	5911-5023051225	MB 58,220/50-60 Hz coil	Coil
5.4	5911-5023051262	M 2 pilot NC	Pilot valve
5.5	5925-34022070	U12/16e 4,0 A 1,1-1,5kw	B&J Thermo Overload Relay 2,7-4,0 A

12. Troubleshooting

This chapter is a description of some problems that might occur and that can be fixed right away by the operator. In the case of problems that cannot be fixed by the operator it is recommended to contact the Jasopels Service Department for further assistance.

DANGER!

Always disconnect the machine's power and air supply before maintenance, cleaning and other services are performed on the machine.



12.1 The belts are making a howling noise

When the belts become too dry, they can begin to make a noise when the drum is running.

Moisten the belts with water or rub stearine on the drum's **belt ring**.

12.2 The drum does not stop

As described in chapter 7, the drum is supposed to stop in its starting position when the tumbling time is up and the drum has been emptied. It is the inductive sensing device (shown in fig. 2.3) together with the sensing plate at the top of the drum that determines the lid's position when the drum stops.

When the switch (fig. 1.1) is set to 9, the tumbling time is set to one hour.

If the sensing plate is missing, the drum will not stop after the emptying process is completed.

If the inductive sensing device is damaged or incorrectly adjusted so the distance between it and the sensing plate is too big, the drum will not stop. On the sensor there are two nuts that need to be adjusted so that the distance between the sensing plate and the end of the sensor is about 3-4 mm. The sensor is adjusted correctly if the little light at the end of the sensor's wire blinks every time the sensing plate passes the sensor.

If the end of the sensor has been deformed after having been too close to the drum, it can be defective. In this case you will not see the light at the end of the sensor blink when the sensing plate passes.

12.3 The drum does not get emptied

If only a few animals come out when the drum is supposed to be emptied, it may mean that the unloading grates have not been lifted.

Make sure that the compressor's pressure is at least 8 bar.

There may be a leak in the air tube between the control box and the air cylinder inside the body drum.

DANGER!
If you need to do maintenance work inside the drum, the power cable MUST be removed from the wall outlet before you start.



13. Conveyor belt

The BS Teknik Self-emptying Body Drum can be combined with a conveyor belt, the purpose of which is to optimize the capacity of the slicing machine / skinning robot. This increase in capacity can be achieved by having a mink ready at all times for the operators of the mentioned machines.

The conveyor belt and body drum can be placed end-to-end or perpendicularly to each other. The conveyor belt must be placed in such a way that one of the raised shields is placed under the body drum's unloading grate.

To connect the conveyor belt to the body drum connect the 4-pin CEE extension plug from the drum with the 4-pin plug by the motor protection of the conveyor belt. The conveyor belt's 5-pin CEE plug needs to be connected with the tap that has been installed underneath of the body drum's control box.



CEE plug for sensing cable

5-pin CEE plug from drum to conveyor belt



13.1 How to operate the conveyor belt

When the conveyor belt has been set up and connected with the body drum, the system is ready to be used.

The conveyor belt can be controlled from the body drum in the following way: when the drum begins to unload, the belt will start running in small steps in order to load all of the belt's length with mink. When the photosensor's beam of light at the end of the belt is interrupted, the belt stops. After that the automatic control unit makes sure that the belt is started/stopped as the mink are removed. When the last mink has been removed, the conveyor belt will run for about 10 seconds without stopping. After that it will stop and will then be ready to run again.

If the photosensor's beam of light is interrupted during the emptying phase, the conveyor belt will switch from running in small steps to running without stopping until the beam of light is interrupted again. This will cause the mink to be transported to the operator quicker.

A safety bow has been installed at the end of the conveyor belt. Applying pressure on the bow causes the belt to stop immediately. The restart procedure is described below.

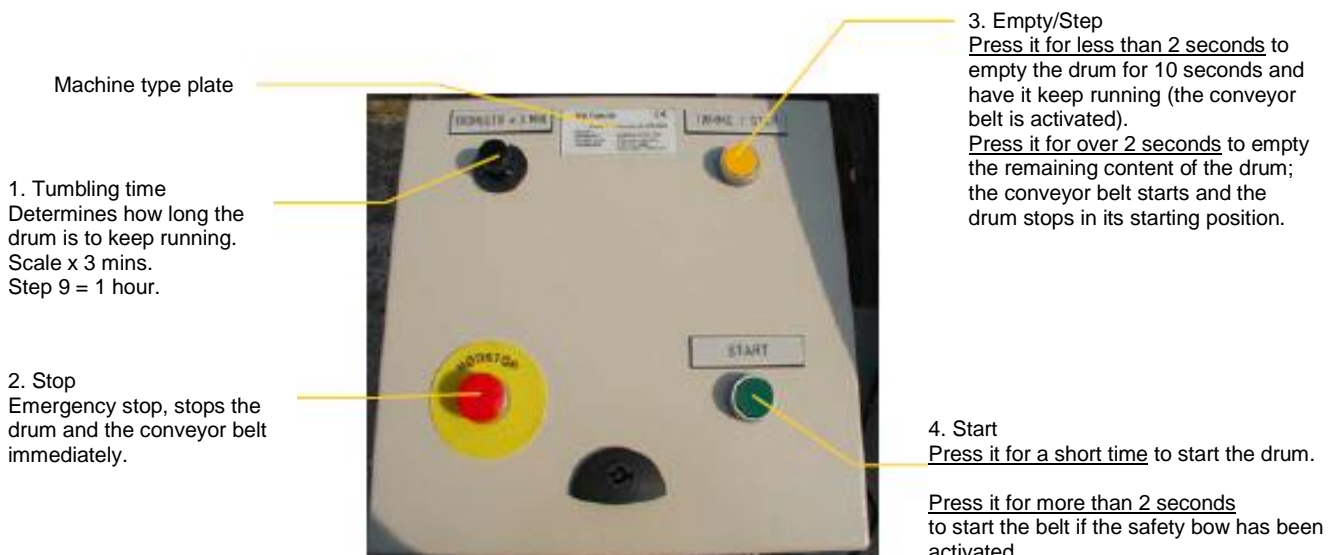

Fig. 2

When the drum is not running and you only want the conveyor belt to start:
Press the **EMPTY** button and keep it pressed. Press **START** for a short time and release the **EMPTY/STEP** button after that.