

# JASOPELS SOFT BRUSH

ITEM NO. 31400001



**Our quality – Your choice**





## TABLE OF CONTENTS

---

1. Preface .....	3
2. Declaration of Conformity.....	5
3. Symbol explanation.....	6
4. Introduction of the machine.....	7
5. Start-up .....	7
6. Operation .....	8
7. Maintenance.....	8
8. Technical data .....	10
9. Circuit diagram .....	11
10. Spare parts list .....	14
11. Notes.....	15

## 1. PREFACE

---

- This User Manual is an important part of your new machine. Read the manual thoroughly and use it as a reference book.
- This manual contains important information about safety and the correct use of the machine.
- The manual should be stored with the machine. It is important that the user manual is supplied with the machine upon resale and lending.
- The owner of the machine must make sure that the operator, service personnel and others who have access to the machine have been instructed in the correct use and handling of the machine. Refer to this user manual for further information.
- Unauthorized modifications, additions or changes to are not allowed for the sake of overall safety. Neither the manufacturer nor the supplier can be held liable for damages incurred as a result of the above. All and any risks in the case of such misuse are the end user's alone.



## 2. DECLARATION OF CONFORMITY

---

### EU DECLARATION OF CONFORMITY

Machine: Soft Brush  
Type: 53-0000

Manufacturer: Jasopels A/S  
Tel.: +45 98 42 05 66  
Address: Fabriksvej 19 DK-7441 Bording

### JASOPELS A/S DECLARES THAT THIS PRODUCT IS IN ACCORDANCE WITH THE FOLLOWING EU DIRECTIVES:

- 2006/42/EC
- 2006/95/EC
- 2006/108/EC

### FURTHERMORE, WE DECLARE THAT RELEVANT CHAPTERS OF THE FOLLOWING HARMONIZED STANDARDS HAVE BEEN APPLIED:

- EN 60204-1
- DS/EN 12100 : 2005
- DS/EN 14121-1
- DS/EN 14121-2
- DS/EN 13857 : 2008
- DS/EN 13850

### STATEMENT ISSUED BY:

Name: Poul A. Bach  
Company: Jasopels a/s  
Address: Fabriksvej 19  
Town: DK-7441 Bording

Signature:



Date: January 31, 2010

**CEO, Poul A. Bach, Fabriksvej 19, DK-7441 Bording, is entitled to supply technical files.**

Updated: September 27, 2016

### 3. SYMBOL EXPLANATION

---

- Please read this user manual and follow the included instructions. In order to emphasize certain information, the following expressions are used:

#### NOTE!



A triangle with an exclamation mark is a symbol that warns you of important instructions or information concerning this machine.

#### DANGER!



A triangle with a flash of lightning is a symbol that warns you of "High Voltage".

#### WARNING!



A triangle warning you of entanglement and crush hazard.

## 4. INTRODUCTION OF THE MACHINE

---

- The Jasopels Soft Brush is designed for softening mink skins.
- After being treated using the Soft Brush, the skins are soft and fluffy. They are ready to be delivered to the customer.
- The machine is simple and easy to use.

### NOTE!

- Make sure to read the manual before using the machine.
- The owner of the machine must make sure that the operator, service personnel and others who have access to the machine are instructed on the proper use and handling of the machine.
- The machine may only be used for the purpose it is designed for. The CE Declaration becomes void upon any other use of the machine.
- If any problems occur with the machine or its operation, the machine must be properly shut off before the problem is fixed, unless the correction can be made using the machine's control keys.
- The user manual must always be kept available for the operator.



## 5. START-UP

---

- Before start-up the machine must be placed on a firm and level floor.
- The manufacturer has equipped the machine with a 5-pin 16 A CEE plug at the end of the power cable. The machine must be connected to an outlet with 3P+N+PE. An air connection has been installed by the electrical cabinet. It includes a filter and a water separator, where the compressed air hose from the compressor is to be connected.
- A suction device can be connected to the machine. This will remove loose hair and sawdust from the skin's outer side and prevent hair and sawdust from being thrown around the room.
- The Soft Brush is now ready to be used.



### DANGER!

Always disconnect the machine's compressed air and electrical power supply before maintenance, cleaning and other service activities are performed on the machine.



In order to avoid potential damage to the control unit's microcontrollers and the rest of the machine's electrical system due to thunderstorms, it is recommended to disconnect the machine from its electrical power source whenever it is not being used.

## 6. OPERATION

---

After the Soft Brush has been correctly connected, it is ready to be used.

At the back of the machine there are two switches. The machine is started using the black one and switched off using the red one.



When the machine is started the chain with the skin transporter runs continuously. The skin is put on one of the hooks with the back side facing out. After that it gets pulled through the machine from left to right and then pushed out of the machine.

After this treatment the skin is ready to be delivered to the customer!

### **DANGER!**

Avoid putting your fingers into the machine's inlet and the area around the skin remover as this can lead to entanglement and crushing.



## 7. MAINTENANCE

---

### 7.1 Belt replacement

### **DANGER!**

If you need to clean the machine or perform maintenance of it, the electrical power cable and the air-pressure supply hose **MUST** be disconnected before you begin.



- Begin by removing the panel on the back side of the Soft Brush.
- After that you can remove the belt. The belt can be loosened/tightened using the oblong holes for the motor bracket. *znajdujących się na wsporniku silnika.*





- The last step is putting the panel back on.

## 7.2 Tightening the chain

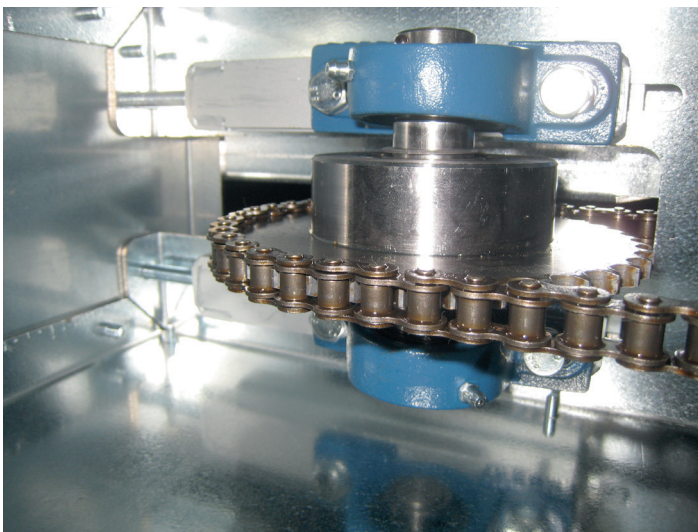

- The bolts by the bearing housing need to be loosened. Tightening takes place from outside using the tightening bolt.

### **DANGER!**

If you need to perform maintenance of the machine, the power cable and the air-pressure supply hose **MUST** be disconnected before you begin.



## 7.3 Brush replacement

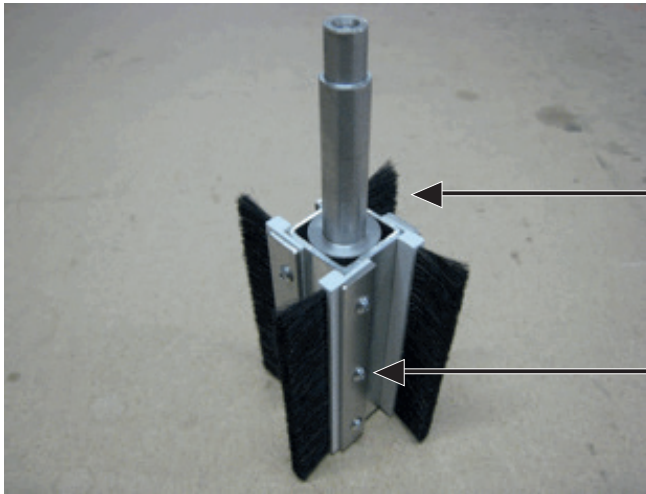

### Spare part

51900022

Brush for skin cleaner 150 mm

Loosen the 3 bolts using  
an Allen key

The Soft Brush needs almost no maintenance but the brushes tend to suffer from normal wear and tear. When the brushes need to be replaced, proceed in the following way:

- Shut off and disconnect the power and air supply.
- Unscrew the screens.
- Each brush is fitted using 3 Allen bolts. Unscrew the 3 bolts, remove the old brush, put the new one in and fasten the 3 bolts again. Repeat this procedure for all brushes that need to be replaced.
- Screw the screens back on.
- Connect the air and power supply and resume work.
- At the end of the season the machine needs to be cleaned with compressed air. When the cleaning process is finished, all lubricant nipples on the bearings need to be lubricated.

### DANGER!

If you need to perform maintenance of the machine, the power cable and the air-pressure supply hose **MUST** be disconnected before you begin.



## 8. TECHNICAL DATA

Electrical connection	3 x 400 V + PE 5-pin CEE plug
Energy consumption	16 A
Air connection	Quick release coupling
Air consumption	Max. 8 bar 50 l/min
Dimensions	Height: 77 cm
	Length: 235 cm
	Width: 81 cm

# 9. CIRCUIT DIAGRAM

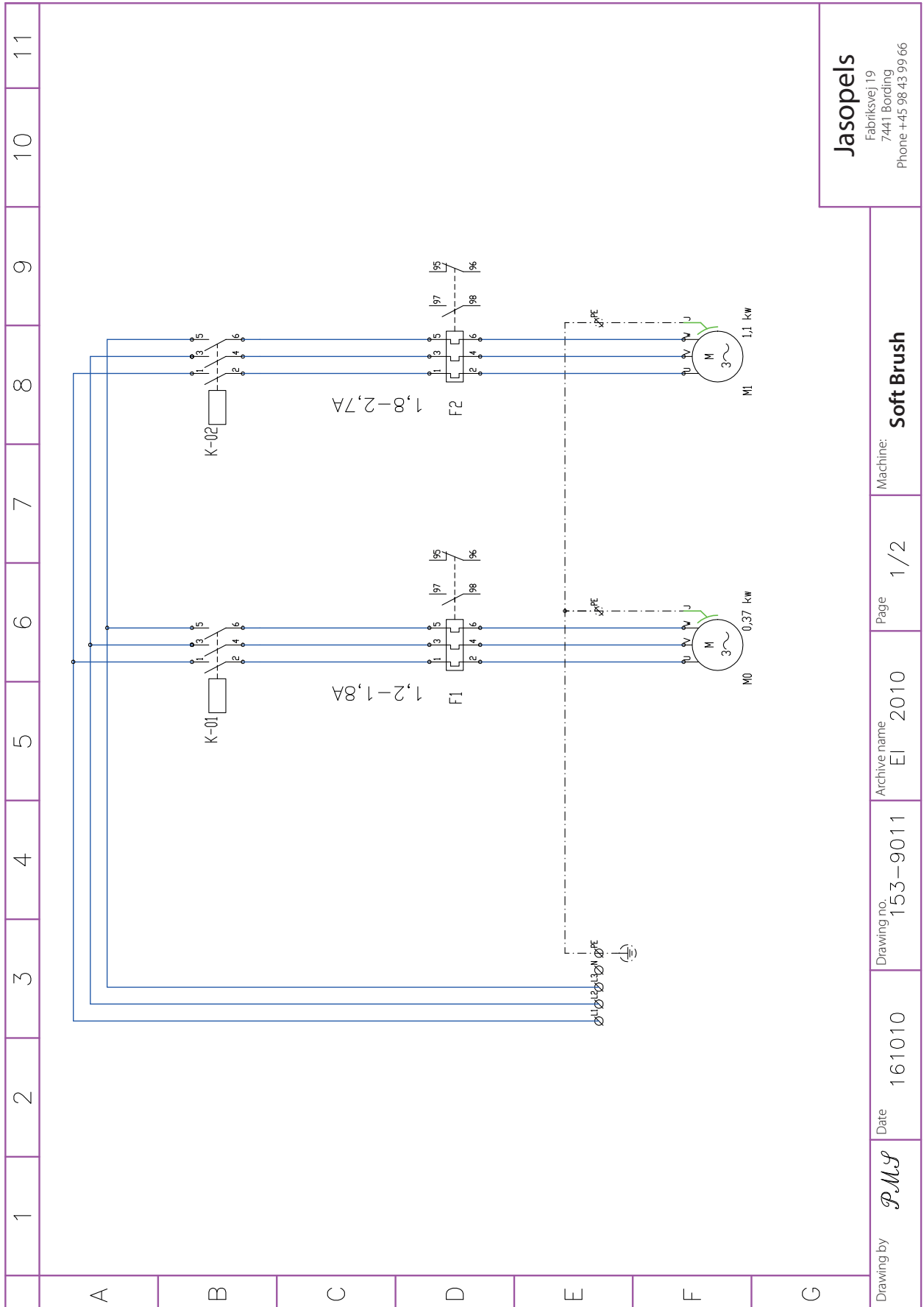

**Jasopels**  
 Fabriksvej 19  
 7441 Bording  
 Phone +45 98 43 99 66

Machine: **Soft Brush**

Page 1 / 2

Archive name EI 2010

Drawing no. 153-9011

Date 161010

Drawing by *PMS*

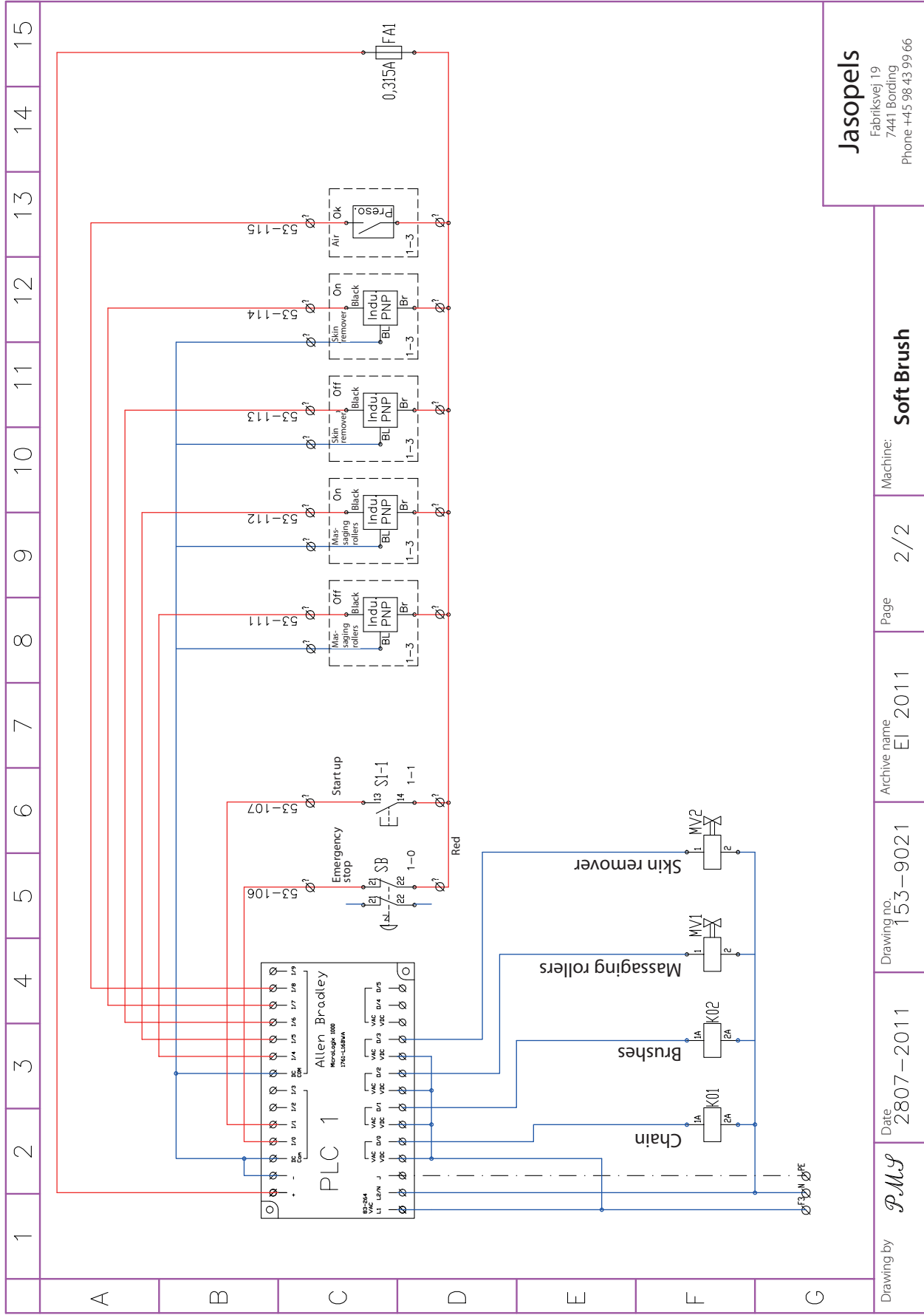

**Jasopels**  
 Fabrikšvej 19  
 7441 Bording  
 Phone +45 98 43 99 66

Drawing by	<i>PMS</i>	Date	2807-2011	Drawing no.	153-9021	Archive name	EI 2011	Page	2/2	Machine:	<b>Soft Brush</b>
------------	------------	------	-----------	-------------	----------	--------------	---------	------	-----	----------	-------------------

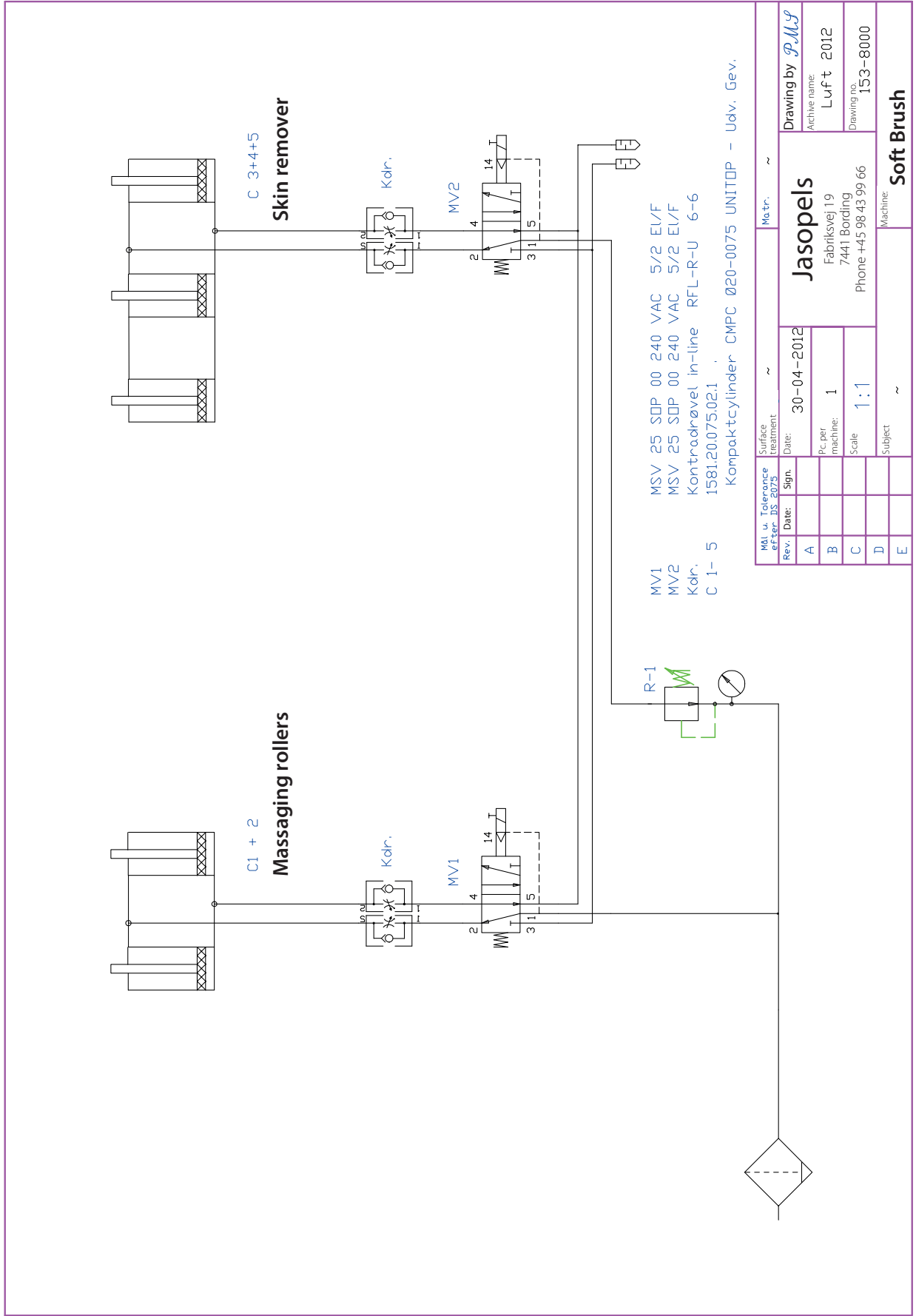

MV1 MSV 25 SDP 00 240 VAC 5/2 EI/F  
 MV2 MSV 25 SDP 00 240 VAC 5/2 EI/F  
 Kotr. Kontradrøvel in-line RFL-R-U 6-6  
 C 1- 5 1581.20.075.02.1  
 Kompaktcylinder CMPC Ø20-0075 UNITOP - Udv. Gev.

M&T u. Tolerance	Surface treatment	Matr.
Rev. Date: Sign.	Date:	~
A	30-04-2012	
B	Pc. per machine: 1	
C	Scale 1:1	
D	Subject	
E		

**Jasopels**  
 Fabrikksvej 19  
 7441 Bording  
 Phone +45 98 43 99 66

Drawing by *P.M.S.*  
 Archive name: Luft 2012  
 Drawing no. 153-8000

Machine: **Soft Brush**

## 10. SPARE PARTS LIST

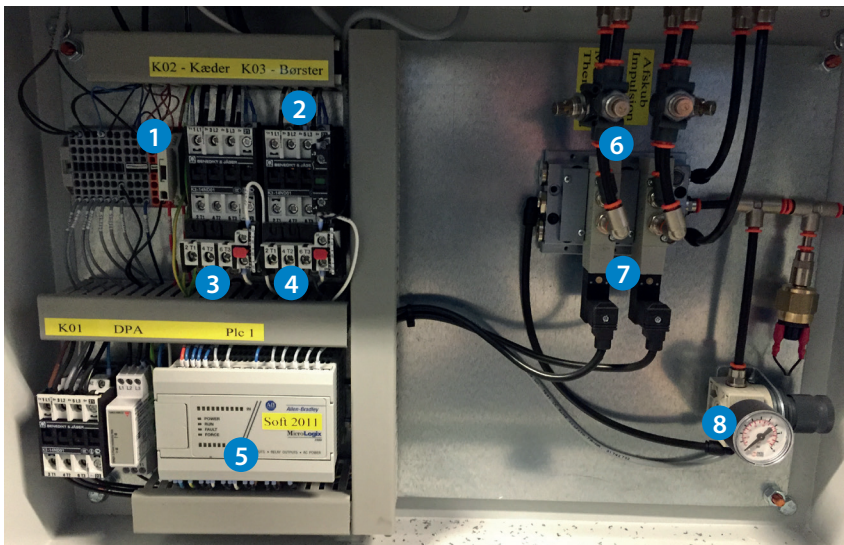

	Item no.	Description
1.	59200134	Component clamp
2.	59200448	B & J contactor K2-12A01-230V
3.	59200488	B & J thermo overload relay 1,2-1,8 A
4.	59200489	B & J thermo overload relay 1,8-2,7 A
5.	59200588	Microcontroller 1761-L16BWA
6.	59100020	Choker in-line RFL-R-B 6-6
7.	59100055	MSV 25 SOP 00 220AC 5/2 EI/F
8.	59100515	Regulator MR bit 1/8 08 bar
	59200280	Inductive sensor Ø 12 PNP
	59200289	Inductive sensor Ø 18 PNP NO

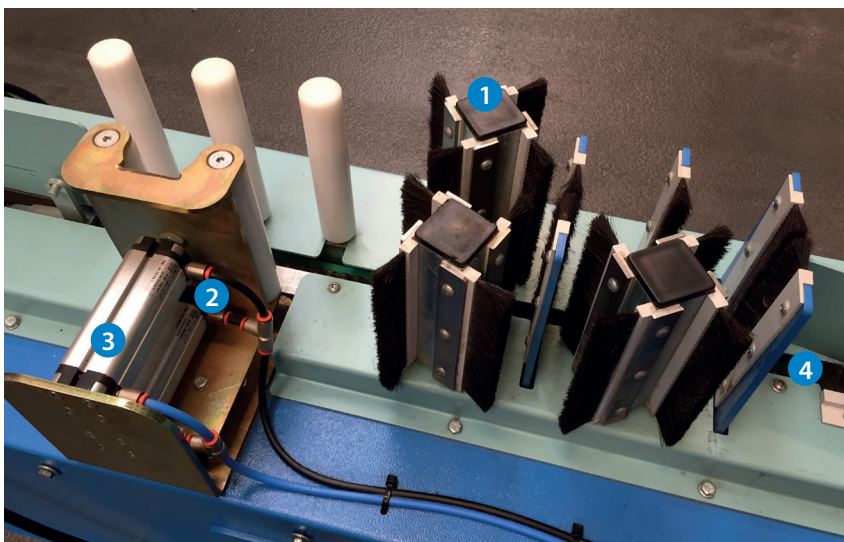

	Item no.	Description
1.	51900022	Brush for skin cleaner 150 mm
2.	59400155	Guiding bracket Size 20
3.	59100250	Compact cylinder CMPC Ø20-0075
4.	59600109	Roller chain 1/2"
	59300021	Brush motor
	59300025	Chain motor





## Our quality – Your choice

Fabriksvej 19 • DK-7441 Bording • Phone +45 98 42 05 66 • [info@jasopels.com](mailto:info@jasopels.com) • [www.jasopels.com](http://www.jasopels.com)

Item no. 31400008



31400008